



Supplying All Your Packaging







Shop Online At
www.PackagingGB.co.uk

Tel: 01283 551050
Sales@PHFlexible.com

Contents

1	How We Can Help Bespoke bubble wrap, foam bags, made to measure cardboard boxes, packaging systems.	
8	Product Catalogue A selection of our most popular products, to place an order either call ourselves, email or order online.	
9	Bubble & Foam Small and large bubble wrap rolls, bubble bags, insulation bags, anti-static bags, foam rolls, foam bags and foam profiles.	
15	Cardboard Single and double wall boxes, layer pads, bottle boxes, kraft rolls, corrugate rolls and fan folded cardboard.	
20	Adhesive Tape Packaging tape, printed tape, masking tape, paper tape, crossweave tape, tape dispensers and gummed paper tape.	
26	Polythene Bags Lightweight, Medium & heavy duty polythene bags, heat sealers, layflat tubing, grip seal bags, vacuum pouches, stand up pouches and compostable products.	
35	Palletising Supplies Document enclosed, cardboard edge guards, shipping labels, top sheets, Ripack heat guns, centrefold shrink film, pallet covers, pallet wrap and pallet machines.	
42	Postal Supplies Padded bags, grey mailers, book wraps, postal tubes and bubble mailing bags.	
46	Strapping Products Polypropylene, polyester and steel strapping with tools, seals, kits and strapping machines all available.	
58	Retail Bags Take away bags, kraft paper bags, block bottom bags, printed warning bags, greeting card bags, handle carrier and variguage bags.	
60	Glue Guns And Staplers Industrial staplers, hammer, treadle, carton staplers with a range of staples. 12 and 18mm industrial glue guns, fast set, multipurpose and high strength glue sticks.	

Product Recycling Codes

	Can be recycled, usually by council collections.
	The product contains or is available in a version which contains 30% recycled content.
	The product contains or is available in a version which contains 100% recycled content.
	The product can be composted. Either at home or in an industrial compost site.
	Low density polyethylene, recycling code 04

Conversion Charts

Micron	Gauge	Millimetres	Inches	Paper Size	Millimetres
30	120	25	1	A3	297 x 420mm
62.5	250	127	5	A4	210 x 297mm
125	500	254	10	A5	148 x 210mm
250	1000	508	20	A6	105 x 148mm

How To Order



By Phone - 01283 551050



By Email - Sales@PHFlexible.com



Online - www.PackagingGB.co.uk

How We Can Help You

Bubble Wrap and Recyclabubble®

We manufacture bubble wrap rolls and convert these into a variety of products, including;

- Bubble Tubing,
- Self Seal Bubble Bags,
- Double Laminate Bubble Bags,
- Anti-Static Bags,
- Metalised Bags.

Recyclabubble® has at least 30% recycled content and is available in our range of bubble based products.

We can provide you with bespoke protective packaging to meet your specifications.

Bubble Rolls

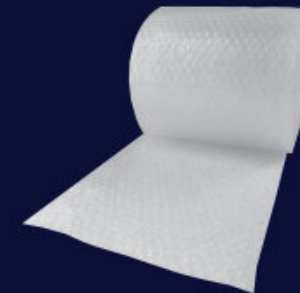

- Small or large bubble versions.
- Range of stock sizes available.
- Contain 30% recycled content.

Insulation Bags



- Perfect for temperature controlled requirements.
- The layer of bubble and metalised film help to maintain your products from the outside environment.

Bubble Bags



- Available with or without a self seal adhesive lip.
- Stock or bespoke sizes to meet your requirements.
- Can also be made from anti-static material or double laminated.

Need A Box Maker?



All In One Packaging Service

Our packaging service can take care of your packaging requirements, leaving you to concentrate on the other important aspects.

We can supply a regular delivery of bespoke cardboard boxes, as well as all the other packaging products you use.



Design

We create the optimum box for you, either a bespoke design or a FEFCO style which meets your needs.



Sample

A sample allows you the chance to see an example of the finished product, to test it, modify it and when you are happy with it, approve it.



Manufacture

When you have approved the project, we will begin making it to the desired specification.



Ship

Once complete we will ship the order. This can be to your own sites, your customer's (on white labels if required) or as part of a call off schedule if agreed earlier.

Step 1 - Pick Your Box Style

The most popular box styles are shown below, if yours is not shown, we can make a full range of FEFCO styles.

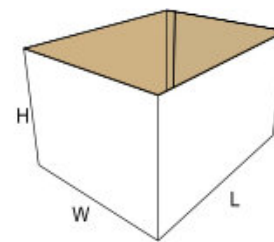

0200

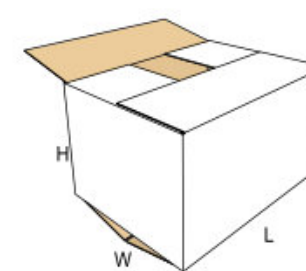

0201

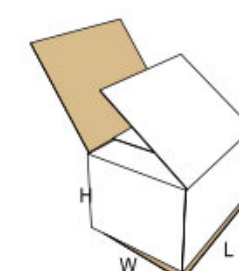

0203

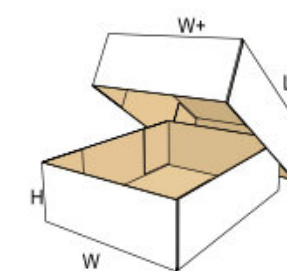

0300

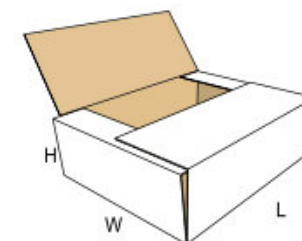

0401

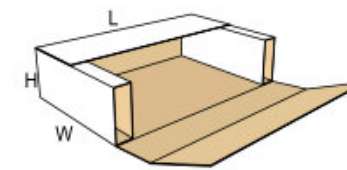

0403

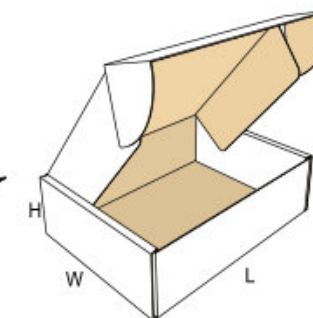

0427

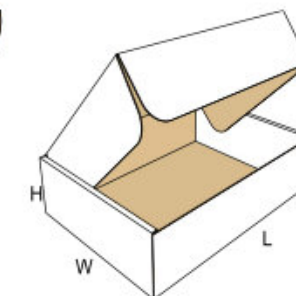

0429

Step 2 - Pick Your Cardboard Grade

Depending on the weight of your product and method of transport used for delivery we will help determine which board grade is most appropriate.

Single Wall - B125KT - Suitable for lightweight requirements, constructed from a single B flute with a kraft outer paper layer and a recycled paper inner layer.



Standard Double Wall - BC125KT - Can be used for shipping items up to 30kg comfortably through the postal system. Features an additional flute layer over the lighter grade single wall.



Heavy Duty Double Wall - BC300KT - Thicker papers on this version help to increase strength of the board. Ideal where the items are either heavy, or easily breakable and require a high level of protection.



Step 3 - Choose Your Quantity

Step 4 - Send Your Enquiry

Email - Sales@PHFlexible.com
Tel - 01283 551050

Packaging Systems

We are partnered with key companies to provide on demand packaging machines. These include paper based, air bubble based and pallet wrap machines, offering you a range of methods to streamline your packaging process.



We Provide

To ensure we provide the best system for you, we carry out a site visit, look at what you are aiming to achieve and provide the appropriate solution.

This could be a yearly saving on pallet wrap consumables, a reduction in packaging materials used for sending goods out or a streamlined process which increases your dispatch rate per day.



We Offer

- Increased efficiency.
- Consistent packaging process.
- Expert guidance on the most suitable systems for your business.
- A reliable source of packaging consumables.



Paper

- All paper is FSC certified.
- Adds compression strength to parcels.

Several machines offering various advantages.

Chevron provides cylindrical tubes of paper. Perfect for void fill and small items.

Papillion is easily integrated to existing setups and is constructed from 2 layers of 20cm wide paper.



Air

- At least 50% Recycled content.
- Provide bubble protection to your breakables.

Save space on storage by using an inflate on demand system.

Range of machines include options to cushion, provide void fill, wrap or block and brace.



Pallet Wrap

- Increase pallets wrapped per day.
- Provides potential savings on film costs.

There are savings to be made if you wrap a high amount of pallets a day.

The machine can stretch the film and can use pre-stretch film. This can provide a reduction in the weight of film used but maintain a secure pallet.

Foam



Foam Conversion

We provide foam rolls in varying thicknesses and convert the foam rolls into bags and sheets.

If you use foam, contact ourselves and see how we can help your business.

Foam Bags

- 5 Stock sizes.
- Can be made bespoke.

Foam bags provide cushioning protection and will not cause abrasion to your product.

Foam Sheets

- Stock sizes available and can be produced to your size.

Foam sheets provide a way of stopping two of your items damaging each other.

These can be used as dividers, reducing the damage caused.

Packaging Supplies

- We can manage all of your packaging requirements.
- Take the stress out of your packaging supply chain.

Whether it is bespoke or stock items, we can either make your packaging, or supply your packaging and deliver it to you as you require. This allows you to focus on selling your own products.



Product Catalogue



Bubble Rolls

- Sold by the roll.
- Recyclabubble® contains 30% recycled content.
- Use as a void fill, or wrap your breakable items with our bubble.

SKU	Width	Length
SMB300	300mm	100m
SMB500	500mm	100m
SMB600	600mm	100m
SMB750	750mm	100m
SMB900	900mm	100m
SMB1000	1000mm	100m
SMB1200	1200mm	100m
SMB1500	1500mm	100m



Bubble Rolls - Large

- Sold by the roll.
- Recyclabubble® contains 30% recycled content.
- Larger individual bubbles provide extra protection.

SKU	Width	Length
BRS300	300mm	50m
BRS500	500mm	50m
BRS600	600mm	50m
BRS750	750mm	50m
BRS900	900mm	50m
BRS1000	1000mm	50m
BRS1200	1200mm	50m
BRS1500	1500mm	50m



Bubble Bags - Double Laminate

- A thicker self seal bag with an extra layer of material providing a smooth finish.
- Recyclabubble® contains 30% recycled content.
- Used for products which need a heavier duty bubble bag.

SKU	Size	Bags / Box
DLBB1	100 x 135mm	750
DLBB2	130 x 180mm	500
DLBB3	180 x 235mm	300
DLBB4	230 x 285mm	300
DLBB5	280 x 360mm	150
DLBB6	305 x 435mm	150
DLBB7	380 x 435mm	100



MAKE IT BESPOKE

Bubble Bags With Self Seal

- Protect items from damage with our bubble bags.
- Recyclabubble® contains 30% recycled content.
- Available in a full range of sizes and can be made bespoke.

SKU	Size	Bags / Box
BB1	100 x 135mm	750
BB2	130 x 180mm	500
BB3	180 x 235mm	300
BB4	230 x 285mm	300
BB5	280 x 360mm	150
BB6	305 x 435mm	150
BB7	380 x 435mm	100



MAKE IT BESPOKE

Bubble Bags - Flush Top

- No self seal on this bag, perfect for when you only require a pouch.
- Recyclabubble® contains 30% recycled content.
- Fully recyclable.

SKU	Size	Bags / Box
FTBB1	100 x 135mm	750
FTBB2	130 x 180mm	500
FTBB3	180 x 235mm	300
FTBB4	230 x 285mm	300
FTBB5	280 x 360mm	150
FTBB6	305 x 435mm	150
FTBB7	380 x 435mm	100



MAKE IT BESPOKE

Insulation Bags

- Stock and bespoke size available.
- Used for temperature control of products. The silver surface provides reflective benefits, meaning it can slow down the temperature changes effecting your products on the inside.

SKU	Size	Box Qty
IB1	180 x 250mm + Lip	500
IB2	200 x 350mm + Lip	250
IB3	300 x 350mm + Lip	125
IB4	400 x 350mm + Lip	125
IB5	490 x 490mm + Lip	100
IB6	620 x 555mm + Lip	50



MAKE IT BESPOKE

We manufacture metalised insulated bags for the distribution of chilled food and pharmaceutical industries.

- Perfect for temperature controlled requirements.
- Preserving the internal temperature for longer.

Bubble Bags

Bubble Bags - Anti-Static

- For electrical items which help to stop static charges damaging the components.
- Self seal lip provides secure closure.

SKU	Size	Bags / Box
ASBB1	100 x 135mm	750
ASBB2	130 x 180mm	500
ASBB3	180 x 235mm	300
ASBB4	230 x 285mm	300
ASBB5	280 x 360mm	150
ASBB6	305 x 435mm	150
ASBB7	380 x 435mm	100



MAKE IT BESPOKE

Bubble Tubing

- Recyclabubble® contains minimum 30% recycled content.
- Can be cut and heat sealed closed at the required length.
- Protect long items from damage.

SKU	Size	Unit
BT100	100mm x 75m	Roll
BT001	250mm x 75m	Roll
BT002	300mm x 75m	Roll
BT003	500mm x 75m	Roll



MAKE IT BESPOKE

Bubble Sheets

- Interleave sheets between your items to protect from damage.
- Recyclabubble® contains 30% recycled content.

SKU	Size	Sheets / Box
BSA5	150 x 210mm	2000
BSA4	200 x 300mm	1000
BS34	300 x 400mm	500
BS35	300 x 500mm	500



MAKE IT BESPOKE

Bespoke Bubble Bags

- Low MOQ
- Perfectly fit your product.
- Optional self seal lip.
- 30% Recycled content.

Request A Quote
Tel - 01283 551050
Email - Sales@PHFlexible.com

Foam Bags

Foam Bags

- Protect items from damage with our foam bags.
- Bespoke sizes are available.

SKU	Size	Bags / Box
FB10X15	100 x 150mm	500
FB12X20	150 x 200mm	500
FB15X25	150 x 250mm	500
FB25X36	250 x 360mm	250
FB30X50	300 x 500mm	250



MAKE IT BESPOKE



Foam Rolls

- Choice of 4 thicknesses - 1mm, 1.5mm, 2.5mm and 4mm thick.
- Provides non abrasive cushioning, stops items damaging each other.

SKU	Size mm	Thickness
FR1	1000mm x 300m	1mm
FR2	1500mm x 300m	1mm
FR3	1000mm x 200m	1.5mm
FR4	1500mm x 200m	1.5mm
FR5	1000mm x 120m	2.5mm
FR6	1500mm x 120m	2.5mm
FR7	1000mm x 75m	4mm
FR8	1500mm x 75m	4mm



Foam Sheets

- 1mm thick foam sheets offer non abrasive protection, ideal for interleaving between items.
- Sold by the box.
- Can be made bespoke to your requirements.

SKU	Size	Bags / Box
FSA5	150 x 210mm	2000
FSA4	200 x 300mm	1000
FS34	300 x 400mm	500
FS35	300 x 500mm	500



MAKE IT BESPOKE

Ocean Green U Fix 2m

- Made from 100% recycled content.
- Used for edge protection.
- All sizes are internal

SKU	A	B	C	D	Metres Per Box
U FIX 15	3	16	30	7	500
U FIX 18	5	18	30	8	350
U FIX 25	10	24	35	9	280
U FIX 35	20	35	43	11	180
U FIX 45	25	44	53	12	160
U FIX 60	30	58	64	14	100
U FIX 80	45	76	72	15	80
U FIX 100	60	96	72	19	64
U FIX 120	90	120	85	20	48

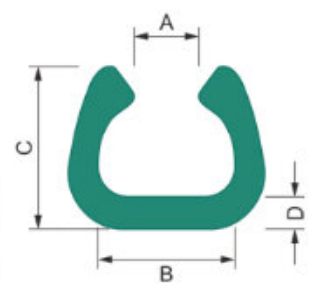

Ocean Green Corner Pieces

- Made from 100% recycled content.
- Used for corner protection.
- All sizes are internal.

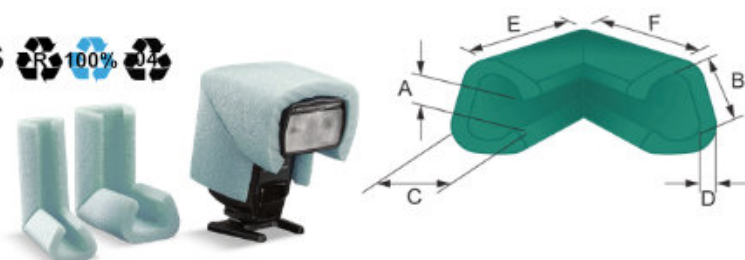

SKU	A	B	C	D	E	F	Pieces Per Box
U FIX 15	3	16	30	7	100	100	900
U FIX 25	10	24	35	9	100	100	600
U FIX 35	20	35	43	11	100	100	400
U FIX 45	25	44	53	12	100	100	300
U FIX 60	30	58	64	14	100	100	200
U FIX 80	45	76	72	15	100	100	160

Ocean Green C Corner Pieces

- Made from 100% recycled content.
- Used for edge protection.
- All sizes are internal.

SKU	A	B	Pieces Per Box
C70/10	70	10	3100
C70/20	70	20	2000
C100/12	100	12	1300
C100/20	100	20	800

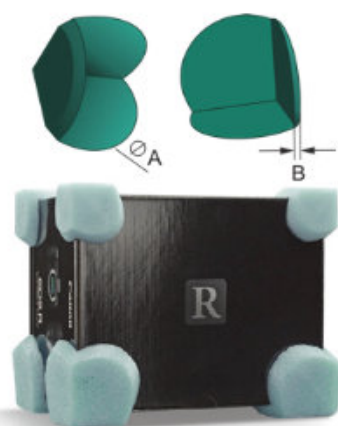

Foam Blocks

- Stratocell foam blocks, used for internal void fill inside boxes.
- Strong and reusable. Available in black and white.

SKU	Size mm	Box Qty
STRATO1	400 x 300 x 25mm	40
STRATO2	500 x 400 x 25mm	25
STRATO3	600 x 400 x 25mm	25
STRATO4	600 x 600 x 25mm	40
STRATO5	600 x 600 x 50mm	20
STRATO6	600 x 600 x 100mm	10



Self Adhesive Foam Pads

- Block out voids in boxes to protect your items.
- Self adhesive on one side for easy application.

SKU	Size mm	Box Qty
FPADS1	50 x 50 x 25mm	1000
FPADS2	100 x 100 x 25mm	480

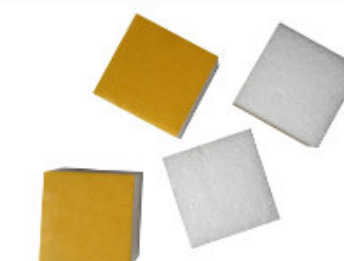

Closed And Open Corner Protection

- The cost of the edge of your products having an imperfection on during transport can be costly. Closed edge protectors could save you from this.

SKU	Flange Width mm	Depth	Box Qty	Closed / Open
CCP15	60 x 60mm	15mm	1000	Closed
CCP18	60 x 60mm	300m	1000	Closed
CCP22	60 x 60mm	300m	850	Closed
CCP28	60 x 60mm	300m	700	Closed
CPRO-1	60 x 60mm	28mm	1000	Open

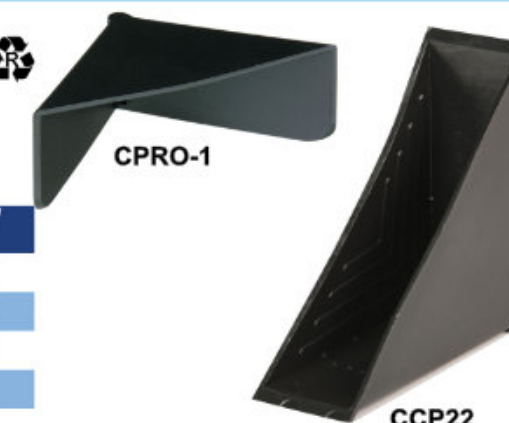

Plastic Edge Protection

- Securing your items with strapping can cause damage to you products during tensioning. These plastic edge guards help prevent this happening.

SKU	Size	Usable Width	Box Qty
CPS	28 x 25mm	19mm	2000
CPL	37 x 32mm	30mm	1000
CCL-X	48 x 42mm	40mm	1000
CPX	57 x 48mm	50mm	1000
CPL-SPIKE	37 x 32mm	30mm	2000



Cardboard & Paper Packaging

Paper Rolls

Pure Kraft Rolls

- Pure kraft rolls, sold by the roll.
- Used for wrapping and interleaving between items.

SKU	Size mm	GSM
KR450	450mm x 280m	70gsm
KR500	500mm x 280m	70gsm
KR600	600mm x 280m	70gsm
KR750	750mm x 280m	70gsm
KR900	900mm x 280m	70gsm
KR1200	1200mm x 280m	70gsm
KR90088	900mm x 220m	88gsm

Imitation Kraft Rolls

- Made from 100% recycled content.
- Sold by the roll.

SKU	Size mm	GSM
IR600	600mm x 180m	90gsm
IR900	900mm x 180m	90gsm
IR1200	1200mm x 180m	90gsm



Corrugated Paper Rolls

- Use as void fill, or environmentally friendly protection to wrap products in.
- Sold by the roll.

SKU	Size
CR-200	200mm x 75m
CR-300	300mm x 75m
CR-600	600mm x 75m
CR-750	750mm x 75m
CR-1000	1000mm x 75m
CR-1200	1200mm x 75m
CR-1500	1500mm x 75m
CR-1800	1800mm x 75m



Void Fill Centrefeed Paper Rolls

- Made from 100% recycled content.
- Sold by the roll. Perfect for using as void fill or layers between items. Each roll weights 15.8kg.

SKU	Size mm	GSM
CPR	375mm x 650m	65gsm



Cardboard Boxes

Single Wall Cardboard Boxes



MAKE IT BESPOKE



- Lightweight packing boxes made from single wall B flute.
- Bespoke sizes available too.
- All sizes are internal.

SKU	Size mm	Inches	Pack Qty	Pallet Qty
56892	127 x 127 x 127mm	5 x 5 x 5"	25	2400
12688	152 x 152 x 152mm	6 x 6 x 6"	25	2400
57184	152 x 152 x 178mm	6 x 6 x 7"	25	2400
DN4	160 x 150 x 170mm	6.5 x 5 x 7"	25	1050
58005	178 x 127 x 127mm	7 x 5 x 5"	25	2400
44033	178 x 178 x 178mm	7 x 7 x 7"	25	1200
58723	203 x 203 x 203mm	8 x 8 x 8"	25	1200
12681	229 x 152 x 152mm	9 x 6 x 6"	25	1800
12692	230 x 230 x 130mm	9 x 9 x 5"	25	1200
59014	254 x 152 x 152mm	10 x 6 x 6"	25	1600
12701	254 x 254 x 254mm	10 x 10 x 10"	25	800
59061	279 x 279 x 178mm	11 x 11 x 7"	25	800
86031	305 x 229 x 80mm	12 x 9 x 3"	25	1200
86090	305 x 229 x 102mm	12 x 9 x 4"	25	1200
86092	305 x 229 x 114mm	12 x 9 x 4.5"	20	1200
86095	305 x 229 x 127mm	12 x 9 x 5"	25	1200
13837	305 x 229 x 152mm	12 x 9 x 6"	25	1200
53296	305 x 229 x 178mm	12 x 9 x 7"	20	1200
86099	305 x 229 x 203mm	12 x 9 x 8"	25	800
13836	305 x 229 x 229mm	12 x 9 x 9"	25	1200
53297	305 x 229 x 305mm	12 x 9 x 12"	20	800
12702	305 x 305 x 305mm	12 x 12 x 12"	25	400
59131	330 x 254 x 178mm	13 x 10 x 7"	25	800
1366	320 x 150 x 150mm	13 x 6 x 6"	25	1600
15107	370 x 250 x 180mm	15 x 10 x 7"	25	800
12705	381 x 254 x 254mm	15 x 10 x 10"	25	800
59138	381 x 330 x 305mm	15 x 13 x 12"	25	400
59142	381 x 381 x 381mm	15 x 15 x 15"	25	400
16911	400 x 230 x 280mm	16 x 9 x 11"	25	640
12695	406 x 356 x 203mm	16 x 14 x 8"	25	400
53425	432 x 318 x 318mm	17 x 12.5 x 12.5"	20	400
16202	445 x 315 x 267mm	17.5 x 12.4 x 10.5"	20	400
44900	450 x 350 x 160mm	17.7 x 13.8 x 6.3"	25	400
12707	457 x 305 x 305mm	18 x 12 x 12"	25	400
59168	483 x 305 x 305mm	19 x 12 x 12"	25	400
12703	508 x 356 x 356mm	20 x 14 x 14"	25	200
12708	508 x 381 x 254mm	20 x 15 x 10"	25	400
12696	510 x 457 x 406mm	20 x 18 x 16"	20	160
12697	610 x 457 x 305mm	24 x 18 x 12"	20	160
12698	610 x 457 x 457mm	24 x 18 x 18"	20	140

Double Wall Cardboard Boxes



MAKE IT BESPOKE



- Range of stock sized cardboard boxes, sold by the pack.
- We also make bespoke sized boxes.
- All sizes are internal.

SKU	Size mm	Inches	Pack Qty	Pallet Qty
59178	200 x 200 x 200mm	8 x 8 x 8"	15	540
59783	229 x 152 x 152mm	9 x 6 x 6"	20	900
59788	254 x 254 x 254mm	10 x 10 x 10"	20	400
86094	305 x 229 x 114mm	12 x 9 x 4.5"	20	600
86096	305 x 229 x 127mm	12 x 9 x 5"	20	600
30385	305 x 229 x 152mm	12 x 9 x 6"	15	540
74190	305 x 229 x 178mm	12 x 9 x 7"	20	400
35280	305 x 229 x 229mm	12 x 9 x 9"	10	360
59184	305 x 305 x 200mm	12 x 12 x 8"	15	360
59122	305 x 305 x 305mm	12 x 12 x 12"	15	360
59798	350 x 350 x 350mm	14 x 14 x 14"	20	160
59794	406 x 406 x 406mm	16 x 16 x 16"	10	90
59187	410 x 410 x 230mm	16 x 16 x 9"	15	180
59155	457 x 305 x 254mm	18 x 12 x 10"	15	180
59192	457 x 305 x 305mm	18 x 12 x 12"	15	180
59790	457 x 457 x 305mm	18 x 18 x 12"	15	90
59190	457 x 457 x 457mm	18 x 18 x 18"	15	90
59182	510 x 510 x 525mm	20 x 20 x 21"	15	90
59170	559 x 508 x 406mm	22 x 20 x 16"	15	90
59795	566 x 366 x 254mm	22 x 14 x 10"	15	180
59801	581 x 406 x 312mm	22 x 16 x 12"	15	90
59799	610 x 254 x 330mm	24 x 10 x 13"	15	180
59193	610 x 457 x 457mm	24 x 18 x 18"	15	90
59800	610 x 508 x 406mm	24 x 20 x 16"	15	90
97671	610 x 610 x 610mm	24 x 24 x 24"	10	100
59188	711 x 711 x 406mm	28 x 28 x 16"	15	75
59792	762 x 457 x 457mm	30 x 18 x 18"	10	90
312022	790 x 520 x 560mm	31 x 20 x 22"	10	90

Quik Wrap Nano



- Manual boxed paper wrapping system.
- Honeycomb paper and tissue paper provide protection to your products.
- The system is kerbside recyclable.
- No power required.



SKU	Size	GSM
QUIKWRAP	Honeycomb W500mm x L105m	Honeycomb - 80GSM
	Tissue Paper W305mm x 105m	Tissue Paper - 20gsm



Cardboard Sheets

Layers Pads / Pallet Liners

- Protect products from damage on base of pallets.
- Improve stacking stability by placing layer sheets between your products.

SKU	Size mm	Board Grade	Pack Qty
PL-EURO-SW	800 x 1000mm	B Flute	100
PL-EURO-DW	800 x 1000mm	BC Flute	50
PL-STAND-SW	1000 x 1200mm	B Flute	100
PL-STAND-DW	1000 x 1200mm	BC Flute	50



Fan Fold Corrugated Cardboard

- Continuous sheets of corrugated, fan folded onto pallets, ideal for wrapping large products, such as signs.
- Sold by the pallet.

SKU	Board Grade	Width	M ² /Pallet
990BKT1	Single Wall B Flute	990mm	495
1122BKT1	Single Wall B Flute	1122mm	561
1257BKT1	Single Wall B Flute	1267mm	634
970EBKT2	Double Wall EB Flute	970mm	312
1280EBKT2	Double Wall EB Flute	1280mm	412
1600EBKT2	Double Wall EB Flute	1600mm	515
980BCKT35	Double Wall BC Flute	980mm	216
1230BCKT35	Double Wall BC Flute	1230mm	271
1800BCKT35	Double Wall BC Flute	1800mm	398



Beer Bottle Presentation Boxes

- Presentation packs for your bottles products. Ideal for gift sets and showcasing your range.
- 330ml and 500ml versions as standard.

SKU	Size mm	Colour	Pack Qty
330-K	188 x 60 x 230mm	Kraft	20
330-W	188 x 60 x 230mm	White	20
500-K	233 x 79 x 258mm	Kraft	20
500-W	233 x 79 x 258mm	White	20



Cardboard Sheets

- We can supply corrugated cardboard sheets.
- Low MOQ.
- Full range of board grades and sizes available.

Common Grades
 Single Wall B Flute 125KT
 Double Wall BC Flute 125KT
 Double Wall BC Flute 300KT

Adhesive Tape



Tape Dispensers

Standard Dispenser



PG50B

- Suitable for 50mm wide tape on a 75mm core.
- Takes 66m and 132m length rolls.
- Adjustable brake.

Bonus Tape Dispenser



BT50B

- Takes 200m tape.
- For use with 25mm core bonus tape.

E Tape Dispenser



ET50B

- Takes 100m tape on 50mm core.
- Takes most 150m tape on 50mm core.

Pre-Set Tape Dispenser



SL3

- Variable tape lengths up to 200mm.
- Suitable for tape between 25mm and 75mm.

Enclosed Tape Dispenser



D250

- For use with 50mm wide crossweave tape.

Clamp On Bench Dispenser



CBD50

- Dual core. 2x25mm or 1x50mm wide tapes.
- No tools required.

Bench Dispenser



HMB50

- Metal construction, dual core bench dispenser.
- 2x25mm or 1x50mm.

Heavy Duty Combination Tool



BD50

- Dual core, 2x25mm or 1x50mm.
- Can take 132m tape.

Trio Dispenser

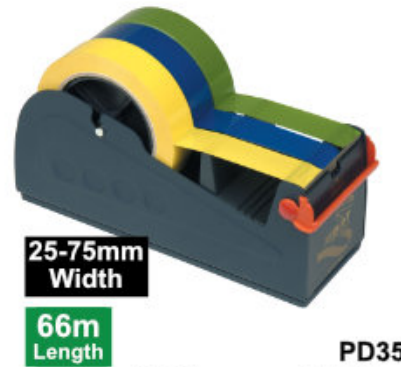

PD351

- Use 3x25mm or 1x75mm wide tape.
- Takes 66m long tape rolls.

Parcel Tape

- A range of packing tape to suit all your needs when dispatching parcels.
- All supplied on 3 inch cores, suitable for use with handheld dispensers.
- Sold by the roll.

SKU	Description	Size	Colour	Rolls Per Box
25MM-S	25mm Solvent Tape	25mm x 66m	Clear	72
Techno-S-B	Techno Solvent	48mm x 66m	Brown	36
Techno-S-C	Techno Solvent	48mm x 66m	Clear	36
Techno-LN-B	Techno Low Noise Solvent	48mm x 66m	Brown	36
Techno-LN-C	Techno Low Noise Solvent	48mm x 66m	Clear	36

Vibac and 3M tape ranges are also available. **VIBAC 3M**



Printed Tape

- Message tape informs the handler to be careful with a particular parcel.
- 48mm x 66m. Sold by the roll.
- Bespoke tape available too.

SKU	Description	Adhesive
PT-FTS	Fragile	Solvent
PT-FTA	Fragile	Acrylic
PT-HWC	Handle With Care	Acrylic
PT-TWU	This Way Up	Acrylic
PT-R	Reject	Acrylic



Masking Tape

- Typically used where a low tack is required, providing the ability to remove when required. Ideal for artists, sign makers and kitchen fitters.
- 48mm x 50m. Sold by the roll.

SKU	Description	Rolls Per Box
MT24	24mm (1 Inch) Ivy	72
MT48	48mm (2 Inch) Ivy	36



Machine Tape

- Machine rolls are used on box sealing machines, where the longer roll reduces the amount of change overs.
- Sold by the box.

SKU	Description	Rolls Per Box
3M 371-38	3M 371 Clear 38mm x 990m	8
3M 371-48	3m 371 Clear 48mm x 990m	6



Adhesive Tape

Kraft Paper Tape

- Eco friendly tape made from a paper backing layer and acrylic adhesive.
- Tear by hand for easy application.



SKU	Description	Size	Rolls Per Box
Techno-Paper	Techno Paper Tape	48mm x 50m	36

Crossweave Tape

- Reinforced crossweave has two directional filament providing a very strong level of adhesion.



SKU	Description	Size	Rolls Per Box
CWT25	Reinforced Crossweave	25mm x 50m	36
CWT50	Reinforced Crossweave	50mm x 50m	18



Printed Tape

- Increase brand awareness.
- Minimum order quantity of 72 rolls.
- Range of adhesives.
- Print on polypropylene or paper tape.

Gummed Paper

Gummed Paper Tape - Plain

- Full range of gummed tape options, sold by the box.
- Strong adhesive and more environmentally friendly tape option when compared to traditional polypropylene backed tapes.



SKU	Width mm	Length m	GSM	Colour	GSI / GSO
K4820B-60GSI	48mm	200m	60gsm	Brown	In
K4820B-60GSO	48mm	200m	60gsm	Brown	Out
K4820W	48mm	200m	70gsm	White	In
K4820B-70GSI	48mm	200m	70gsm	Brown	In
K7020B-90GSI	70mm	200m	90gsm	Brown	In
K7020B-90GSO	70mm	200m	90gsm	Brown	Out
K9620B-60GSI	96mm	200m	60gsm	Brown	In
76mm Core					
K5020C76B-60GSI	50mm	200m	60gsm	Brown	In
K7015C76B-90GSO	70mm	150m	90gsm	Brown	Out
K7020C76B-60GSI	70mm	200m	60gsm	Brown	In
K9620C76B-70GSO	96mm	200m	70gsm	Brown	Out
Reinforced 38mm Core					
KR6030B-GSI	60mm	300m	125gsm	Brown	In
KR6030B-GSO	60mm	300m	125gsm	Brown	Out
KR7030B-GSO	70mm	300m	125gsm	Brown	Out
KR7030B-GSI	70mm	300m	125gsm	Brown	In

Gummed Paper Tape - Reinforce Print

- Use preprinted gummed paper tape as a method of seeing if your parcel has been tampered with.

SKU	Width mm	Length m	Message	GSI / GSO
KR7015-SENSEAL	70MM	152M	Sentry Seal	In



Gummed Paper

Gummed Paper Machines

- Paper tape machines are required if you are using gummed paper tape. The water tank applies water to the tape which activates the adhesive.



BP555

- Preset popular tape length buttons.
- Customise length to 12.7mm increments.
- Set a pattern of tape length for repeated box sealing.
- Set to GSI by default but can be altered to GSO if requested.

Specification	
Max Tape Width	76mm
Max Tape Weight	125gsm
Tape Applied From Water Tank	2500m
Tape Capacity	305m
Compatibility	Plain or Reinforced
	GSI & GSO



BP500

- Preset popular tape length buttons.
- Set to GSI by default but can be altered to GSO if requested.
- Max roll length of 200m

Specification	
Max Tape Width	76mm
Tape Capacity	200m
Compatibility	Plain or Reinforced
	GSI & GSO



BBP222

- Manually operated machine for on the go dispatching. No power source required.
- Push lever produces 254mm of tape, repeat process for extra tape.

Specification	
Max Tape Width	70mm
Max Tape Diameter	152mm
Tape Applied From Water Tank	114m
Compatibility	GSI



EPS80

- Entry level tape dispenser, pull the tape through as required.

Specification	
Max Tape Width	80mm
Compatibility	Plain only

Polythene Supplies



Compostable Bags

- Complies with EN 13432
- Designed to disintegrate in industrial composting conditions within 12 weeks.
- Can be home composted, but process will take longer.



Appearance

The bags are either a cloudy white, white or green. This means your product will not be showed off when inside, like traditional polythene bags.

To help differentiate between polythene bags and compostable bags, these have a print all over to inform the recipient of the qualities of this bag and help ensure the bag is disposed of correctly. The print reads as follows "Compostable for a better world...Material Conforms To EN 13432"

How to store?

Due to the nature of this product, it is vital that the product is not stored near heat sources, sunlight, or humidity. The product should be used within 6 months.

For best performance store between the following:

- Temperature: 17-23°
- Humidity: 35-55%

How to dispose?

The compostable bags are designed for disposal in industrial compost units, taking approx 90 days. You can compost the bags at home, but it will take more than 90 days.

If the bags end up in a landfill site, the lack of oxygen and moisture dramatically slows down the time taken to break down the product. This is best avoided for environmental reasons.

Compostable Bags

SKU	Width x Length	Micron	Pack Qty
COMP1	150 x 200mm	20	400
COMP2	200 x 250mm	20	400
COMP3	250 x 300mm	20	400
COMP4	300 x 450mm	20	200
COMP5	450 x 600mm	20	200
COMP6	200 x 250mm	40	400
COMP7	250 x 300mm	40	400
COMP8	300 x 450mm	40	200
COMP9	450 x 600mm	40	200



Compostable Mailing Bags

- Feature peel and seal closure.
- EN13432 compliant.
- Available in cloudy white and green.

SKU	Width x Length	Micron	Colour	Pack Qty
MNATC5	160 x 230mm	40	Cloudy	200
MNAT21	170 x 250mm	40	Cloudy	200
MNATC4	230 x 325mm	40	Cloudy	200
MNAT31	250 x 350mm	40	Cloudy	200
MNAT41	300 x 420mm	40	Cloudy	200
MNAT51	400 x 540mm	40	Cloudy	200
MCOMPGRNC5	160 x 230mm	50	Green	200
MCOMPGRN21	170 x 250mm	50	Green	200
MCOMPGRNC4	230 x 325mm	50	Green	200
MCOMPGRN31	250 x 350mm	50	Green	200
MCOMPGRN41	300 x 420mm	50	Green	200



Compostable Carrier Bags

- Printed compostable and renewable leaf logos to show green credentials.
- EN13432 compliant.
- Larger sizes feature bottom gusset.

SKU	Width x Length	Micron	Pack Qty	Colour
CBCNAT1	200 x 300mm	60	500	White
BIOCB2	375 x 450mm	65	100	White
CBCNAT4	375 x 450mm (90mm base gusset)	60	200	White
CBCGRN4	75 x 450mm (90mm base gusset)	60	200	Green



Compostable Bin Bags & Liners

- Printed compostable and renewable leaf logos to show green credentials.
- EN13432 compliant.
- Natural starch based bags suitable for disposal of kitchen and garden waste.

SKU	Open/Closed Width x Length	Micron	Capacity	Pack Qty
WCOMCLR01	275/400 x 450mm	17	8-12 Litres	200
WCOMCLR03	325/575 x 750mm	20	45 Litres	100
WCOMAXCLR03	325/575 x 750mm	40	45 Litres	100
WCOMAXCLR05	450/725 x 975mm	40	85 Litres	50
WCOMAXCLR07	550/860 x 1175mm	40	150 Litres	25
WCOMAXCLR09	750x1150 x 1350mm	40	270 Litres	10



Polythene Bags

- Available in three thicknesses, lightweight, medium and heavy duty. Our polythene bags contain 30% recycled content.
- Pair with a heat sealer for sealing the open end of the polythene bag.

Light Duty Polythene Bags

- 28 Micron / 120 gauge.
- Contain 30% recycled content.
- Sold by the pack.

SKU	Width x Length mm	Size ins	Pack Qty
PB1120g	75 x 100	3 x 4	1000
PB2120g	75 x 125	3 x 5	1000
PB3120g	100 x 150	4 x 6	1000
PB4120g	100 x 200	4 x 8	1000
PB5120g	150 x 200	6 x 8	1000
PB6120g	150 X 250	6 x 10	1000
PB7120g	150 x 300	6 x 12	1000
PB8120g	175 x 225	7 x 9	1000
PB9120g	188 x 550	7.5 x 22	1000
PB10120g	200 x 250	8 x 10	1000
PB11120g	200 x 300	8 x 12	1000
PB12120g	225 x 300	9 x 12	1000
PB13120g	250 x 300	10 x 12	1000
PB14120g	250 x 375	10 x 15	1000
PB15120g	300 x 375	12 x 15	1000
PB16120g	300 x 450	12 x 18	1000
PB17120g	350 x 450	14 x 18	1000
PB18120g	375 x 500	15 x 20	1000
PB19120g	450 x 500	18 x 20	500
PB20120g	450 x 600	18 x 24	500
PB21120g	500 x 750	20 x 30	500
PB22120g	600 x 600	24 x 24	500
PB23120g	600 x 900	24 x 36	500
PB24120g	700 x 1050	28 x 42	250
PB25120g	750 x 1200	30 x 48	250
PB26120g	900 x 900	36 x 36	200
PB27120g	900 x 1200	36 x 48	250



Medium Duty Polythene Bags

- 58 Micron / 250 gauge.
- Contain 30% recycled content.
- Protect from dirt and dust, heat seal close.

SKU	Width x Length mm	Size ins	Pack Qty
PB1250g	75 x 100	3 x 4	1000
PB2250g	75 x 125	3 x 5	1000
PB3250g	100 x 150	4 x 6	1000
PB4250g	125 x 200	5 x 8	1000
PB5250g	150 x 200	6 x 8	500
PB6250g	150 x 225	6 x 9	500
PB7250g	150 x 300	6 x 12	500
PB8250g	175 x 225	7 x 9	500
PB9250g	200 x 250	8 x 10	500
PB10250g	200 x 300	8 x 12	500
PB11250g	225 x 300	9 x 12	500
PB12250g	250 x 300	10 x 12	500
PB13250g	250 x 375	10 x 15	500
PB14250g	300 x 375	12 x 15	500
PB15250g	300 x 450	12 x 18	500
PB16250g	300 x 600	12 x 24	250
PB17250g	375 x 500	15 x 20	500
PB18250g	450 x 600	18 x 24	200
PB19250g	450 x 920	18 x 37	100
PB20250g	500 x 750	20 x 30	100
PB21250g	600 x 900	24 x 36	100
PB22250g	700 x 1050	28 x 42	100
PB23250g	900 x 1200	36 x 48	100

30% Recycled Options

- Picking a 30% recycled product means you do not have the additional Plastic Tax applied to your item.
- A product with 30% recycled content in will have a slight grey colouring to it.
- Unfortunately products with recycled content in can not be used in direct contact with food or pharmaceutical uses.

Heavy Duty Polythene Bags

- 120 Micron / 500 gauge.
- Contain 30% recycled content.
- Ideal for heavy duty uses.

SKU	Width x Length mm	Size ins	Pack Qty
PB1500g	75 x 125	3 x 5	1000
PB2500g	100 x 150	4 x 6	500
PB3500g	125 x 175	5 x 7	500
PB4500g	150 x 200	6 x 8	500
PB5500g	150 x 225	6 x 9	500
PB6500g	150 x 300	6 x 12	250
PB7500g	175 x 225	7 x 9	250
PB8500g	200 x 250	8 x 10	250
PB9500g	200 x 300	8 x 12	250
PB10500g	225 x 300	9 x 12	250

SKU	Width x Length mm	Size ins	Pack Qty
PB11500g	250 x 300	10 x 12	250
PB12500g	250 x 375	10 x 15	250
PB13500g	300 x 375	12 x 15	250
PB14500g	300 x 450	12 x 18	250
PB15500g	375 x 500	15 x 20	200
PB16500g	450 x 600	18 x 24	100
PB17500g	500 x 750	20 x 30	100
PB18500g	600 x 900	24 x 36	50
PB19500g	700 x 1050	28 x 42	50
PB20500g	900 x 1200	36 x 48	50

Impulse Heat Sealers

- Seal closed your polythene bags with our range of heat sealers.
- Use the model with cutters for trimming lay flat tubing to size.
- Max sealing thickness of 2 x 150mu film.
- Usage guide - 100 seals per shift.



Impulse Spares Kits

SKU	Contents
IS200KIT	
IS300KIT	1 x Blade 2 x Element
IS400KIT	3 x Upper Teflons 1 x Lower Teflon
IS500KIT	
KIT200	
KIT300	2 x Element
KIT400	3 x Upper Teflons 1 x Lower Teflon
KIT500	

SKU	Width	Cutter	Weight
IS200C	200mm	Yes	3.85kg
IS300C	300mm	Yes	5.00kg
IS400C	400mm	Yes	6.12kg
IS500C	500mm	Yes	8.20kg
IS200	200mm	No	3.85kg
IS300	300mm	No	5.00kg
IS400	400mm	No	6.12kg
IS500	500mm	No	8.20kg

Audion Sealers

We are distributors for Audion products, and can offer the full range of Audion industrial heat sealers and packaging machines. Please send your enquiry to Sales@PHFlexible.com



Lay Flat Tubing

- Make bespoke sized bags with tubing and a heat sealer.
- Contain 30% recycled content.
- Range of gauges to suit your needs.
- Used to wrap long products such as window blinds.



Length per roll - 1" - 24"	
120g	688m
250g	330m
500g	165m
1000g	82m

Width (mm)	Width (ins)	120g	250g	500g	1000g	Weight
25mm	1"		250g (LFT013)	500g (LFT035)		1kg
38mm	1.5"		250g (LFT014)	500g (LFT036)		1.5kg
50mm	2"		250g (LFT015)	500g (LFT037)		2kg
62mm	2.5"		250g (LFT016)	500g (LFT038)		2.5kg
75mm	3"	120g (LFT001)	250g (LFT017)	500g (LFT039)		3kg
100mm	4"	120g (LFT002)	250g (LFT018)	500g (LFT040)	500g (LFT059)	4kg
125mm	5"		250g (LFT019)	500g (LFT041)		5kg
150mm	6"	120g (LFT003)	250g (LFT020)	500g (LFT042)	500g (LFT060)	6kg
175mm	7"		250g (LFT021)	500g (LFT043)		7kg
200mm	8"	120g (LFT004)	250g (LFT022)	500g (LFT044)	500g (LFT061)	8kg
225mm	9"		250g (LFT023)	500g (LFT045)		9kg
250mm	10"	120g (LFT005)	250g (LFT024)	500g (LFT046)		10kg
300mm	12"	120g (LFT006)	250g (LFT025)	500g (LFT047)	500g (LFT062)	12kg
350mm	14"	120g (LFT007)	250g (LFT026)	500g (LFT048)		14kg
375mm	15"		250g (LFT027)	500g (LFT049)		15kg
400mm	16"	120g (LFT008)	250g (LFT028)	500g (LFT050)		16kg
450mm	18"		250g (LFT029)	500g (LFT051)	500g (LFT063)	18kg
500mm	20"	120g (LFT009)	250g (LFT030)	500g (LFT052)		20kg
550mm	22"			500g (LFT053)		22kg
600mm	24"	120g (LFT010)	250g (LFT031)	500g (LFT054)		24kg
650mm	26"			500g (LFT055)		25kg
750mm	30"	120g (LFT011)	250g (LFT032)	500g (LFT056)		25kg
900mm	36"	120g (LFT012)	250g (LFT033)	500g (LFT057)		25kg
1200mm	48"		250g (LFT034)	500g (LFT058)		25kg

Polyolefin

- Used to shrink wrap items and provide a dust cover.
- Better temperature resistance compared to PVC.

SKU	Width mm	Length	Micron
PFIN25	250/500mm	1335m	15mu
PFIN30	300/600mm	1335m	15mu
PFIN35	350/700mm	1335m	15mu
PFIN3019	300/600mm	1070m	19mu



PVC Shrink Film

- Provides crystal clear appearance.
- Requires fume extraction.

SKU	Width mm	Length	Micron
PVC20	200/400mm	600m	19mu
PVC25	250/500mm	600m	19mu
PVC30	300/600mm	600m	19mu
PVC35	350/700mm	600m	19mu
PVC40	400/800mm	600m	19mu
PVC45	450/900mm	600m	19mu
PVC50	500/1000mm	600m	19mu
PVC60	600mm	600m	19mu
PVC80	800mm	600m	19mu



Bar Heat Sealers Kits

- Shrink wrap small items to offer dust protection.

I Bar and L bar shrink sealing kits contain: unroller, hot air gun, stand and the sealer of your choice.



SKU	Max Film Width	Weight
IBAR300KIT	300mm	10kg
IBAR450KIT	450mm	10kg
IBAR600KIT	600mm	10kg
IBAR800KIT	800mm	11.2kg
LBAR300KIT	300 x 300mm	12kg

Grip Seal Bags

- Three version available, standard, 30% recycled content and bags with a write on panel.
- 100% Recyclable.
- Used to group small items together for easy storage.
- Recycled content version not suitable for use with food.



Standard SKU	30% Recycled SKU	Write On Panel SKU	Size mm	Pack Qty	Gauge
G0	G0R	G020	37 x 62mm	1000	160g
G1	G1R	G120	56 x 56mm	1000	160g
G2	G2R	G121	56 x 75mm	1000	160g
G3	G3R	G122	75 x 80mm	1000	160g
G4	G4R	G123	88 x 112mm	1000	160g
G5	G5R	G124	112 x 112mm	1000	160g
G6	G6R	G125	100 x 137mm	1000	160g
G7	G7R	G126	137 x 137mm	1000	160g
G8	G8R	G127	75 x 187mm	1000	160g
G9	G9R	G128	125 x 187mm	1000	160g
G10	G10R	G129	187 x 187mm	1000	160g
G11	G11R	G130	150 x 225mm	1000	180g
G12	G12R	G131	200 x 275mm	1000	180g
GA4	GA4R	G132	228 x 320mm	1000	180g
G13	G13R		320 x 320mm	1000	180g
G14	G14R	G133	250 x 350mm	1000	180g
G15	G15R	G134	275 x 400mm	1000	180g
G16	G16R	G135	325 x 450mm	1000	180g
G17	G17R	G136	375 x 500mm	1000	180g
Heavy Duty Versions					
G19	G19R		88 x 112mm	1000	300g
G20	G20R		125 x 200mm	1000	300g
G30	G30R		175 x 250mm	1000	300g
G40	G40R		200 x 300mm	1000	300g
G50	G50R		225 x 350mm	500	300g
G60	G60R		300 x 400mm	500	300g
G70	G70R		250 x 450mm	500	300g

Vacuum Packing Pouches

- Used for preserving food by removing the air when used with the appropriate machine.
- 7 layer construction, 100% virgin LDPE/Nylon.
- 70 Micron.



SKU	Size mm	Pack Qty
140170	140 x 170mm	1000
150200	150 x 200mm	1000
150265	150 x 265mm	1000
160300	160 x 300mm	1000
180300	180 x 300mm	1000
200200	200 x 200mm	1000
200250	200 x 250mm	1000
200300	200 x 300mm	1000
250250	250 x 250mm	1000
250350	250 x 350mm	1000
270330	270 x 330mm	1000

SKU	Size mm	Pack Qty
300300	300 x 300mm	500
300350	300 x 350mm	1000
300400	300 x 400mm	500
320520	320 x 520mm	500
350450	350 x 450mm	500
360520	360 x 520mm	500
400400	400 x 400mm	500
400500	400 x 500mm	250
400600	400 x 600mm	250
430650	430 x 650mm	250

Stand Up Pouches

- Resealable stand up pouches keep your products fresh.
- Heat seal the top to lock your items inside.
- PET / PE Layers.
- Full range of pouches available on request.



SKU	Filling Guideline	Width x Height x Gusset	SKU	Filling Guideline	Width x Height x Gusset
SUP28	28g	W80 x H130 x G40mm	SUP250	250g	W160 x H230 x G90mm
SUP50	50g	W95 x H150 x G60mm	SUP350	350g	W170 x H250 x G90mm
SUP70	70g	W110 x H170 x G70mm	SUP500	500g	W190 x H260 x G100mm
SUP100	100g	W120 x H200 x G80mm	SUP750	750g	W210 x H310 x G110mm
SUP150	150g	W130 x H210x G80mm	SUP1000	1000g	W235 x H335 x G110mm

100% Recycled Content Polythene Bags

- Uses fewer natural resources.
- Not suitable for food use.
- Contains 100% Recycled material.

SKU	Width x Length	Micron	Pack Qty
46RECY	100 x 150mm	40	1000
68RECY	150 x 200mm	40	1000
1012RECY	250 x 300mm	40	500
1520RECY	375 x 500mm	40	250
1824RECY	450 x 600mm	40	250
2436RECY	600 x 900mm	40	150
3648RECY	900 x 1200mm	40	100



Palletisation



Palletisation

Document Enclosed Wallets

- Choice of printed or plain document enclosed wallets.
- Self adhesive for easy securing to pallets or boxes.

SKU	Internal Size	Box Qty
A7PL	113 x 100mm	1000
A6PL	165 x 122mm	1000
A5PL	225 x 165mm	1000
A4PL	318 x 235mm	500
DLPL	225 x 122mm	1000
A7DE	113 x 100mm	1000
A6DE	165 x 122mm	1000
A5DE	225 x 165mm	1000
A4DE	318 x 235mm	500
DLDE	225 x 122mm	1000



Cardboard Edge Protectors

- Help protect the edge of your pallets from damage during transport.
- Bespoke sizes available with 1000 metres worth of edging.



SKU	Length mm	Width mm	Thickness mm	Pack Qty	Pallet Qty
KEB35.3.1000	1000mm	35 x 35mm	3mm	50	5100
KEB35.3.1200	1200mm	35 x 35mm	3mm	50	4200
KEB35.5.1500	1500mm	35 x 35mm	3mm	50	4200
KEB35.3.1800	1800mm	35 x 35mm	3mm	50	4200
KEB35.3.2000	2000mm	35 x 35mm	3mm	50	4200
KEB50.3.1000	1000mm	50 x 50mm	3mm	50	2700
KEB50.3.1200	1200mm	50 x 50mm	3mm	50	3000
KEB50.3.1500	1500mm	50 x 50mm	3mm	50	3000
KEB50.3.1800	1800mm	50 x 50mm	3mm	50	2700
KEB50.3.2000	2000mm	50 x 50mm	3mm	50	2700

Top Sheets

- Protect the top of your pallets and prevent water damage.
- 1800mm rolls are supplied centre folded.

SKU	Size	Colour	Thickness	Sheets/Roll	Weight
PTSH	1800 x 1800mm	Clear	50 micron	150	20kg
PTSH-2	1800 x 1800mm	Black	50 Micron	150	18kg
HSTSH-1	1800 x 1800mm	Clear	24 Micron	150	12kg
7264S	1800 x 1600mm	Clear	40 Micron	200	27kg 
5656S	1400 x 1400mm	Clear	30 Micron	500	24kg

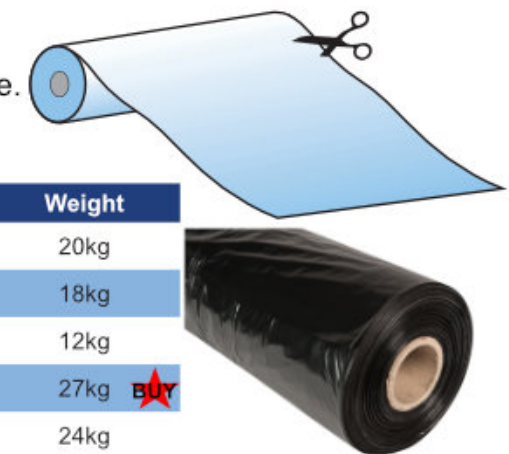

Packaging GB Shrink Gun

- Economical shrink gun, offering performance on a budget.
- 32kw of power.



Ripack 2100

- Entry level Ripack gun, produces 40kw of power.
- Cold nozzle technology means the diffuser remains cold to touch, helping to prevent burns.
- All Ripacks are supplied with regulator, hose and carry bag.



Ripack 2500

- Mid level Ripack gun, produces 34-60kw of power.
- Cover a wide surface area quickly with the lightweight R2500, providing fast, even shrink performance.
- Soft grip and absorbers for comfort while being used.



Ripack 3000

- Top of the range Ripack gun, produces 80kw of power.
- Can be secured with retractable tool balance.
- Tool free ignitor changes.



SKU	Power Output	Weight
Ripack 2100	40kw	920g
Ripack 2500	34-60kw	970g
Ripack 3000	80kw	1000g



Ripack Spares

SKU	Internal Size
134025	Regulator
250023	Hose
148043	Swivel Connection
131003	Ignitor
236022	Ignition Wire
232061	Spark Plug

Ripack Repairs

- We can service and repair your heat shrink tools.
- Send them to ourselves with your return address and any info on the problem you are facing.



Pallet Shrink Covers On A Roll

- Quickly shrink wrap a pallet with premade covers.
- Sized to fit the three most common pallet sizes.
- 125 Micron / 250 gauge, supplied on perforated rolls.

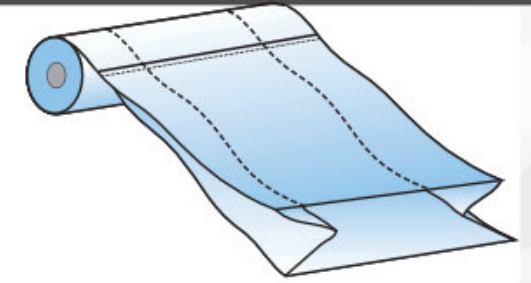

SKU	Cover Size	To Fit Pallet L x W x H	Covers Per Roll	Weight
SPC1280	1300/1250 x 1850mm	1200 x 800 x 1200mm	30	31kg
SPC1210	1300/2350 x 1950mm	1200 x 1000 x 1200mm	30	35kg
SPC1212	1300/2550 x 2050mm	1200 x 1200 x 1200mm	25	34kg

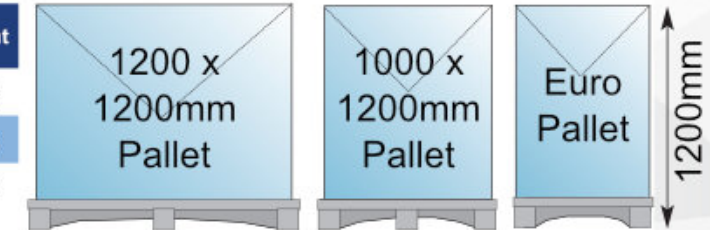

Centrefold Shrink Rolls

- Folded in half to aid storage.
- Cut from the roll to your required length.

SKU	Roll Width	Roll Length	Thickness	Weight
CS1225	1250/2500mm	85m	125mu	26kg
125-1.53M-25	1500/3000mm	74m	150mu	25kg BUY
125-1.2M-25	1000/2000mm	108m	125mu	28kg
125-2-4M-25	2000/4000mm	55m	125mu	27kg
PS004	1000/4000mm	25m	200mu	16kg BUY

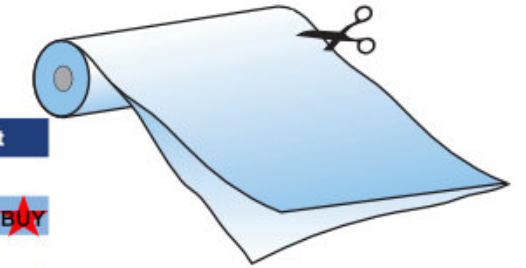

Gusseted Shrink Tubing

- For use with pallets of different height. Cut to your required length.

SKU	Tubing Size	To Fit Pallet L x W	Roll Length	Thickness
GS1012	1250/2250mm	1200 x 1000mm	50m	125mu BUY

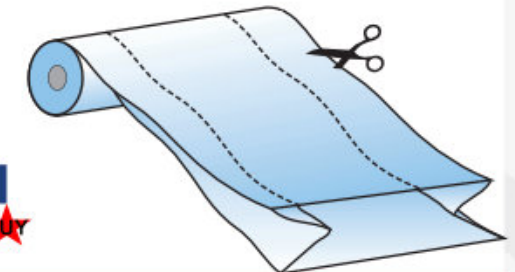

Polythene Sheets

- Multi folded polythene sheets for general use as dust covers.

SKU	Size	Colour	Thickness
2120S	2m open width x 150m	Clear	30mu
2250S	2m open width x 100m	Clear	62mu
2480S	2m open width x 50m	Clear	120mu
4250S	4m open width x 50m	Clear	62mu BUY
4500S	4m open width x 50m	Clear	125mu
41000S	4m open width x 25m	Clear	250mu
41000SB	4m open width x 25m	Black	250mu



Pallet Wrap

- Full range of pallet wrap available. These are our stock sizes. Bespoke options available on pallet quantities.
- 6 Micron roll is pre-stretched.

SKU	Width	Length	Colour	Thickness	Extended Core	Type
6MU	390mm	600m	Clear	6mu	Yes	Blown
14MU	400mm	300m	Clear	12mu	Yes	Cast
17MU-BLACK	400mm	300m	Black	17mu	Yes	Cast
17MU-BLUE	400mm	300m	Blue	17mu	Yes	Blown
17MU-CLEAR	400mm	300m	Clear	17mu	No	Cast
20MU	400mm	300m	Clear	20mu	No	Cast
25MU	500mm	250m	Black	25mu	No	Cast



Mini Stretch Wrap

- 100mm wide rolls of pallet wrap. Used to bundle items together.

SKU	Width	Thickness	Length	Colour
12MU-MINIC	100mm	12mu	300m	Clear
12NU-MINIB	100mm	12mu	150m	Black

HMSC Suitable mini wrap dispenser for use with above mini rolls.

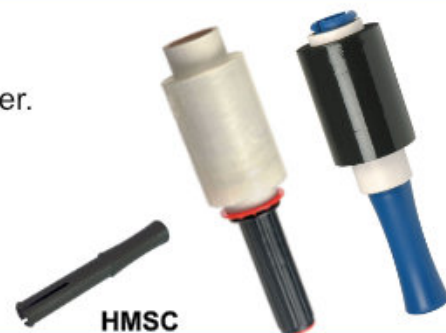

Machine Pallet Wrap

- Suitable for use on your pallet wrap machines, sold by the roll.
- Power pre-stretch film provides greater savings.

SKU	Width	Thickness	Length	Stretch
MPW17	500mm	17mu	1850m	250%
MPW23	500mm	23mu	1375m	175%



Dispensers

Pallet Wrap Dispenser



TMW

- Fits 400mm wide wrap on 38/50/78mm cores.
- Fits 500mm wrap on a 50mm core.

Blown or Cast Film?

- **Cast film** is generally clearer, making it easier to read barcodes through, but there is no added tackifier, meaning it can make loading lorries easier as pallets do not stick together. Not ideal for outside use where the wind could unwind the wrapping.
- **Blown film** has a tackifier added, creating a film which is suitable for outdoor use, but if pallets are packed close together, moving one pallet can cause others to move.

Pallet Cones

Do Not Stack - 100/Pack 



PC001

- Helps to protect your pallets by preventing double stacking.
- Highly visible printed graphics.
- 220 x 220 x 200mm

Saving MPS Semi-Auto Stretch Wrapper Power Stretch Film Carriage



- Table Ø 1650mm, 6mm plate, for pallets up to 1200x1000mm
- Capacity: up to 20 pallets/hour depending on load size
- Wrapping height: up to 2200mm (incl. pallet)
- Max. weight: 2000kg

FEATURES

- Powered film carriage for pre-stretch system (up to 250%)
- Suitable for power-stretch film.
- Photocell for automatic height detection.
- Soft start and stop by return inverter with return to start position.
- 4 Wrapping programs: Single, cross wrap, cross plus, full independently adjustable top and bottom reinforcement wraps.
- Wrapping cycle counter.
- Adjustable vertical film carriage speed.
- Adjustable tension and speed delay.
- Micro-processor controlled; display control panel.
- Optional extras; ramp, pit frame, hold down device.

Film	Stretch Polyethylene
Film Thickness	17-35micron
Film Width	500mm
Rotary Table Height	1650mm
Production Speed	Up to 20 pallets/hr (5.8rpm)*
Pallet Dims	Up to 1200x1000mm
Max Pallet Weight	2000kg
Pallet Height	2200mm
Air Pressure	N/A
Power Supply	240V, Single Phase, 50Hz
Power Consumption	1.2kw

Dimensions and specifications will vary according to customer requirements.
* Please note that different turntable sizes will run at different speeds.

Orbital Wrapper

- Orbital wrappers quickly wrap polythene around your products. The rotating pallet wrap application spiral wraps film around the items, perfect for elongated products, such as timber and window blinds.
- Various models available with diameters of 420mm, 620mm, 1000mm, 1400mm and 2000mm.

Features

- Cutting and clamping between cycles.
- In feed and out feed conveyor, help product stabilisation during wrapping.
- Foot pedal control.
- Power Supply - 230V 1ph.
- Pneumatic power 6 bar.



Shipping Labels

- Informative labels help to reduce damage to parcels and prevent handling errors.
- Sold by the roll.

SKU	Size mm	Labels / Roll	Text
SG89FR	89 x 32mm	1000	FRAGILE
SG89GL	89 x 32mm	1000	GLASS
SG89SO	89 x 32mm	1000	SOLD
SG89HA	89 x 32mm	1000	HANDLE WITH CARE
SG89DO	89 x 32mm	1000	DOCUMENTS ENCLOSED
SG89DN	89 x 32mm	1000	DO NOT BEND
SG148FR	148 x 50mm	500	FRAGILE
SG148HA	148 x 50mm	500	HANDLE WITH CARE
SG148HV	148 x 50mm	500	CAUTION HEAVY PACKAGE
SG108FR	108 x 79mm	500	IMAGE / FRAGILE
SG108TH	108 x 79mm	500	IMAGE / THIS WAY UP
SG108NS	108 x 79mm	500	DO NOT STACK



Labels Dispensers

- Wall or bench mounted.
- Metal body.
- On 25mm or 75mm cores.

SKU	Max roll width	Cores Included
WMD100	100mm	2
WMD160	160mm	4
WMD200	200mm	4
WMD265	265mm	6



Combination Shipping Labels

- Multi-instruction labels convey all handling info on one label.
- Increase packing speed and reduce damages.
- 500 Labels per roll.

SKU	Size	Labels / Roll
COM-LB1	102 x 102mm	500



Bespoke Labels

Low MOQ.
Plain or branded.
Full colour options.
Bespoke size.

Postal Supplies



Need Packaging Advice?

Arrange A Meeting To Discuss Your Needs

We Can Offer

- Bespoke Packaging
- Hold Stock And Deliver When You Require
- Build And Maintain Your Packaging Systems
- 1000's Of Stock Products

Triangle Postal Tubes

- Will not roll on your carriers conveyor belts.
- Self adhesive strip for quick fastening.
- Equilateral triangles.



SKU	Size mm	Max Diameter	Pack Qty
TPT500	500 x 100 x 100mm	60mm	100
TPT750	750 x 128 x 128mm	75mm	100
TPT950	950 x 144 x 144mm	80mm	100
TPT1100	1100 x 155 x 155mm	90mm	100

Postage In Proportion

- Mailing boxes to fit Royal Mail postage requirements.
- Self adhesive strip for quick fastening.
- Dimensions are internal.



SKU	Size mm	Fits Royal Mail	Pack Qty
PIP-L	334 x 243 x 18mm	Large Letter	50

Bubble Lined Mailing Bags 30%

- Protect items through the post with self seal mailing bags.
- Choice of white or gold.
- All sizes are internal.

SKU	Size mm	Size (in)	Colour	Pack Qty
Arofol 1G	100 x 165mm	4 x 6.5"	Gold	200
Arofol 1W	100 x 165mm	4 x 6.5"	White	200
Arofol 2G	120 x 215mm	5 x 8.5"	Gold	100
Arofol 2W	120 x 215mm	5 x 8.5"	White	100
Arofol 3G	150 x 215mm	6 x 8.5"	Gold	100
Arofol 3W	150 x 215mm	6 x 8.5"	White	100
Arofol 4G	180 x 265mm	7 x 10.5	Gold	100
Arofol 4W	180 x 265mm	7 x 10.5	White	100
Arofol 5G	220 x 265mm	8.5 x 10.5	Gold	100
Arofol 5W	220 x 265mm	8.5 x 10.5	White	100
Arofol 6G	220 x 340mm	8.5 x 13.5"	Gold	100
Arofol 6W	220 x 340mm	8.5 x 13.5"	White	100
Arofol 7G	230 x 340mm	9 x 13.5"	Gold	100
Arofol7W	230 x 340mm	9 x 13.5"	White	100
Arofol 8G	270 x 360mm	10.5 x 14"	Gold	100
Arofol 8W	270 x 360mm	10.5 x 14"	White	100
Arofol 9G	300 x 445mm	12 x 17.5"	Gold	50
Arofol 9W	300 x 445mm	12 x 17.5"	White	50
Arofol 10G	350 x 470mm	14 x 18.5"	Gold	50
Arofol 10W	350 x 470mm	14 x 18.5"	White	50



Grey Mailing Bags 100%

- For items which need minimal protection through the post.
- Perfect for a quick dispatch process.
- All sizes are internal.

SKU	Size mm	Size (in)	Thickness	Pack Qty
69MB	150 x 225 + 50mm	6 x 9 + 2	55mu / 220g	1000
912MB	225 x 318 + 50mm	9 x 12 + 2	55mu / 220g	1000
1012MB	250 x 300 + 50mm	10 x 12 + 2	55mu / 220g	1000
1014MB	250 x 350 + 50mm	10 x 14 + 2	55mu / 220g	1000
1216MB	300 x 400 + 50mm	12 x 16 + 2	55mu / 220g	500
1319MB	325 x 475 + 50mm	13 x 19 + 2	55mu / 220g	500
1621MB	400 x 525 + 50mm	16 x 21 + 2	60mu / 240g	500
1822MB	450 x 550 + 50mm	18 x 22 + 2	65mu / 260g	200
2124MB	525 x 600 + 50mm	21 x 24 + 2	65mu / 260g	200
2328MB	575 x 700 + 50mm	23 x 28 + 2	65mu / 260g	200
2436MB	600 x 900 + 50mm	24 x 36 + 2	65mu / 260g	200
2832MB	700 x 800 + 50mm	28 x 32 + 2	65mu / 260g	200
3442MB	850 x 1050 + 50mm	34 x 42 + 2	65mu / 260g	100



Padded Mailing Bags

- Macerated paper provides the cushioning in the padded bag.
- 100% paper bag, easily recyclable.
- All sizes are internal.

SKU	Size mm	Pack Qty
PB00	105 x 229mm	200
PB0	135 x 229mm	200
PB1	165 x 280mm	100
PB2	195 x 280mm	100
PB3	195 x 343mm	100
PB4	225 x 343mm	100
PB5	245 x 381mm	100
PB6	295 x 458mm	50
PB7	341 x 483mm	50



Honeycomb Mailing Bags

- Eco friendly padded postal bag.
- 100% paper, easily recyclable.
- All sizes are internal.

SKU	Size mm	Pack Qty
KPB150215	150 x 215mm	100
KPB240340	240 x 340mm	100



Corrulope Mailing Bags

- Eco friendly postal bag, lined with corrugate fluting to offer protection and strength.
- 100% paper bag, easily recyclable.
- All sizes are internal.

SKU	Size mm	Pack Qty
FLUTE180	180 x 265mm	100
FLUTE240	240 x 320mm	200
FLUTE350	350 x 470mm	50



Book Wrap Mailers

- Quickly pack and ship books.
- Variable height allows for the book wraps to fit items smaller than their maximum dimension.
- All sizes are internal.

SKU	Size mm	Pack Qty
BW55	225 x 155 x 55mm	35
BW70	310 x 250 x 70mm	35
BW106	410 x 320 x 106mm	25



Strapping Supplies



Strapping Codes

- PP** Suitable for use with Polypropylene
- PET** Suitable for use with Polyester
- ST** Suitable for use with Steel
- WP** Suitable for use with Woven Polyester
- CP** Suitable for use with Corded Polyester

Tensioners

- Tensioners for different types of plastic strapping.

Economy Tensioner

PP



TST30

- Entry level tensioner.
- Suitable for up to 19mm polypropylene.

Standard Tensioner

CP

WP



CST20

- Use on on corded and woven polypropylene.
- Suitable strapping width between 9-19mm.

Heavy Duty Tensioner

PP

PET

CP

WP



HPT50

- Use on polypropylene strapping.
- Provides strong strapping tension.
- Improved construction over entry level tensioner.

Sealers

- Sealers secure your seals to the strapping.

Standard Sealer

PP



SGP12

- Entry level sealer.
- Suitable for 12mm polypropylene.

Sealer With Grips

PP

PET



KNS12

- Offset jaws for easy sealing.
- Use with 12mm polypropylene.

Dispensers

Static Dispenser

PP

PET



PSD4

- Use on polypropylene strapping.
- Easily unravel as required.

Combination Tools

- All in one tools that tension and seal.

Standard Combination Tool

PP



SPC12

- Entry level combination tool.
- Suitable for 12mm polypropylene.

Heavy Duty Combination Tool

PP

PET



LPC12

- Use on 12mm polyester and polypropylene.
- Strapping thickness between 0.5-0.99mm.

Mobile Dispenser

PP

PET



PD40

- Use on polypropylene strapping.
- Contains seal tray for easy storage of tools.

Strapping Kits - Polypropylene

- Value for money strapping kits for polypropylene strapping.

Tensioner & Sealer Kit



PPSK1

Contains

- Tensioner.
- Sealer.
- 600m of strapping.
- 250 Seals.

Strapping Kit 5

Our most popular polypropylene starter kit, providing every tool you need to start strapping.

Contains

- Dispenser.
- Tensioner & Sealer.
- 2000m Polypropylene Strapping.
- 1000 Seals.



KIT 5

Combination Starter Kit



PPSK6

Contains

- Combination tool.
- 600m Polypropylene strapping.
- 250 Seals.

Combination Sealer Kit



PPSK7

Contains

- Combination sealing tool.
- 1500m Strapping.
- Static dispenser
- 250 Seals.

Strapping Kit 4



PPSK10

Contains

- Tensioner and sealer.
- 1500m Strapping.
- Mobile dispenser.
- 500 Seals.

Consumable Kit

PP



Contains

- 3 Reels of 2000m polypropylene strapping.
- 2000 seals.

Strapping Kit 6



PPSK20

Contains

- Combination sealing tool.
- 1500m Strapping.
- 500 Seals.
- Mobile dispenser.

Polypropylene Tools Kit

PP



P1212

Contains

- Sealer
- Tensioner

Polypropylene Hand Strapping

- Strapping reels on a plastic core, for use with hand strapping tools.

SKU	Width	Thickness	Length	Breaking Strain
300-003	12mm	0.5mm	2000m	130kg
300-004	12mm	0.7mm	1500m	180kg
300-005	12mm	0.9mm	1000m	300kg



Polypropylene Machine Strapping

- Machine coils of strapping, for use with automatic and semi automatic strapping machines.

SKU	Width	Thickness	Length	Breaking Strain
MS540W	5mm	0.4mm	6500m	60kg
9-4000-MC	9mm	0.55mm	4000m	115kg
PS12	12mm	0.55mm	3000m	135kg
PS12-146	12mm	0.63mm	3000m	146kg



Polyester Hand Strapping

- Extruded polyester strapping is a versatile high performance banding option.

SKU	Width	Thickness	Length	Breaking Strain
PT15G	9mm	0.6mm	3000m	200kg
PT30G	12.5mm	0.7mm	2000m	350kg
PT50G	15.5mm	0.9mm	1500m	560kg



Woven Cord Polyester Strapping

- The stronger safer option when compared to steel strapping.
- 78mm Cardboard cores. Secure with plastic buckles.
- System strength is the combined strap and buckle performance.

SKU	Width	Length	System Strength	Breaking Strain
PW40	13mm	1100m	638kg	375kg
PW55	16mm	600m	1020kg	600kg
PW65	19mm	500m	1235kg	725kg



Seals

- Which seals you require, depends on the type of strapping you have.
- Sold by the box.

SKU	Product	Size mm	Seals / Box	Suitable With
12/25	Semi open seals	12 x 25mm	1000	Polypropylene
12/25HD	Heavy duty semi open seals	12 x 25mm	1000	Polypropylene
SER12-SG	12mm Serrated seals	12 x 30mm	1000	Polyester
SER16-SG	16mm Serrated Seals	16 x 30mm	1000	Polyester
LAP13	13mm Lapover seal	13 x 25mm	1000	Steel
LAP16	16mm Lapover seals	16 x 25mm	1000	Steel
LAP19	19mm Lapover seals	19 x 25mm	1000	Steel
SOS13	13mm Snap on seals	13 x 25mm	1000	Steel
SOS16	16mm Snap on seals	16 x 25mm	1000	Steel
SOS19	19mm Snap on seals	19 x 25mm	1000	Steel



Semi Open



Serrated



Lapover



Snap On

Buckles

- No need for sealing tools when you use buckles, they can be reused too.
- Sold by the box

SKU	Product	Strap Width mm	Wire Diameter	Suitable With	Seals / Box
PB12W-HD	Heavy duty white plastic buckles	12mm	N/A	Polypropylene	1000
CB4S	13mm Sherardised	13mm	3mm	Woven	1000
CB5S	16mm Sherardised	16mm	3.5mm	Woven	1000
CB6S	19mm Sherardised	19mm	3.8mm	Woven	1000
CB8S	25mm Sherardised	25mm	5mm	Woven	400
CB10S	35mm Sherardised	35mm	7mm	Woven	250
CB4G	13mm Galvanised	13mm	3mm	Polypropylene, Woven, Composite, Hotmelt	1000
CB5G	16mm Galvanised	16mm	3.5mm		1000
CB6G	19mm Galvanised	19mm	3.8mm		1000
CB8G	25mm Galvanised	25mm	5mm		500
CB10G	35mm Galvanised	35mm	7mm		250



Plastic Buckles



Galvanised



Sherardised

Semi Auto Strapping Machine

- Use with 5-15.5mm wide polypropylene machine strapping on a 200mm core.
- Tool free roll change overs.

Specification	
Size	L780 x W540 x H750mm
Weight	56kg
Minimum Package Size	W100 x H30mm
Strapping Tension	Max 450N
Suitable Strapping Widths	5,6,9,12,15.5mm



IQ-400

Automatic Strapping Machines - JK5000

- Increase your strapping output, banding automatically wrapped around your product with the press of a button.
- The JK5000 is our entry level automatic machine and is designed for low volume usage.
- Available in two arch sizes, W650 x H400mm and W850 x H600mm.
- Up to 37 straps a minute.
- Compact design with reel fitting under the strapping table.
- Can be setup to use a range of strapping widths with an easy adjustment.

Specification	JK-5000
Size	W921 x W600 x H1436mm
Weight	115kg
Strap Width	5, 6, 9, 12mm*
Table Height	827mm
Strapping Tension	Max 330N
Cycle Time	Up to 35 / minute
Power Supply	100 - 240V Single Phase
Minimum Size	W60 x H30mm
Maximum Size	W620 x H480mm

*12mm strapping recommended.



JK-5000

Automatic Strapping Machines - SQ800

- We can supply a range of fully automated strapping machines to meet your needs.
- Available in two arch sizes, W650 x H400mm and W850 x H600mm. Further widths and heights available on request.
- Strapping rate of 55 cycles per minute.
- Uses a DC motor for cam shaft, meaning less moving parts and less maintenance required.
- Digital tension dial, with a capability to tension up to 450N.
- Adjustable table height.
- Foot bar for hands free operation.

Specification	SQ-800
Size	L1254 x W609 x H1403-1508mm
Weight	146kg
Strap Width	5, 6, 9, 12mm*
Table Height	794-899mm
Strapping Tension	Max 450N
Cycle Time	Up to 55 / minute
Power Supply	100 - 240V Single Phase
Minimum Size	W80 x H30mm
Maximum Size	W620 x H480mm

*Machines set to 9 or 12mm. 5/6mm strapping machines available on request.



Table height adjustment

SQ-800

Semi Auto Strapping Machine

- Use with 6-15mm wide polypropylene machine strapping on a 200 or 280mm core.
- Adjustable table height 730-930mm.

Specification	
Size	L905 x W586 x H760mm
Weight	75kg
Max Product Weight	120kg
Strapping Tension Min/Max	15-45kg
Cycle Time	2.5 Seconds
Power Supply	230V 50Hz



TAS200-AL

Enclosed Semi Auto Strapping Machine

- Use with 6-15mm wide polypropylene machine strapping on a 200 or 280mm core.
- Enclosed cabinet keeps moving parts hidden away.

Specification	
Size	L905 x W586 x H760mm
Weight	100kg
Max Product Weight	120kg
Strapping Tension Min/Max	15-45kg
Cycle Time	2.5 Seconds
Power Supply	230V 50Hz



TMS300

Automatic Strapping Machine

- Increased output, strapping automatically wrapped around your product with the press of a button.
- Two arch sizes available.

Specification	
Size	TRS600-9: L1430 x W620 x H1540mm TRS600-12: L1430 x W620 x H1540mm TRS600-12L: L1630 x W620 x H1740mm
Weight	280kg
Strap Width	TRS600-9: 9mm TRS600-12: 12mm TRS600-12L: 12mm
Strapping Tension Min/Max	10-70kg
Cycle Time	2.2 Seconds
Power Supply	230V 50Hz



TRS600

Strapping Kits - Polyester

- Strapping kits for polyester strapping.

Combination Polyester Kit



EPK13

- Contains**
- Combination sealing tool.
 - 12.5mm x 1600m of polyester strapping.
 - 1000 Serrated seals.

13mm Polyester Tensioner Sealer Kit

Providing all the essentials for polyester hand strapping.

Contains

- Dispenser.
- Tensioner & Sealer.
- 12.5mm x 1600m extruded polyester strapping.
- 1000 Serrated seals.



EXPSK13

Strapping Kits - Woven Polyester

- Strapping kits for woven polyester strapping.

Mobile Dispenser Kit

Holds items without causing damage to your products. Use buckles not seals to secure in place.

Contains

- 13mm x 1100m woven strapping.
- 1000 Metal buckles.
- Mobile dispenser.
- Tensioner.



WPSK13

Extruded Polyester Dispenser

PET



PTD406

Contains

- Easily manage your green polyester strapping with our dispenser and tool tray.

Friction Weld Hand Strapping Tools

- Suitable for use with polypropylene and polyester strapping.
- Feature adjustable tension and sealing time.

Specification	GS1	GSX
Strapping Width	10,13,16mm	16, 19mm
Strapping Thickness	0.5-1.1mm	0.8-1.27mm
Weight	3.7kg	4kg
Strapping Tension	500-2750N	1100-4200N
Cycle Per Charge	150-350	180-300
Charging Time	22 Minutes	30 Minutes



GS1 & GSX

Tensioners For Steel Strapping

- Tensioners for steel strapping.

Standard 19mm Tensioner

ST



TLS20

- Suitable for strapping up to 19mm.
- For use on flat surfaces only.

Heavy Duty Round Pack Tensioner

ST



RP

- For up to 19mm strapping.
- Can be used on irregular surfaces.

Heavy Duty 19mm Tensioner

ST



FP

- Heavy duty 19mm tensioner.
- Use on flat surfaces only.

Sealers

- Sealers secure your seals to the strapping.

Single Notch Sealer

ST



TS12

- Available to suit 3 widths, 13, 16 and 19mm steel strapping.
- Only suitable for use with steel snap on seals.

Heavy Duty Single Notch Sealer

ST



SRD12

- Available to suit 3 widths, 13, 16 and 19mm steel strapping.
- Only suitable for use with steel lap over seals.

Sealless Combination Tool

ST



OHT

- Combination sealless tools are an all in one steel strapping tool.
- No seals required.
- Available in 3 widths.

Strapping Accessories

- Optional safety cutters and dispensers which will make using strapping easier.

Steel Strapping Cutter

ST



SSC06

- Entry level steel safety cutter.
- Will cut a maximum size 0.9mm x 32mm

Heavy Duty Steel Strapping Cutter

ST



SSC08

- Heavy duty safety cutter which can cut 1.2mm x 32mm strapping.

Mobile Steel Dispenser

ST



SD32

- Steel strapping dispensers will make moving the heavy coils around easier.
- Contains seal tray for easy storage of tools.

Strapping

Steel Strapping - Ribbon Wound

- Used to secure heavy stable loads due to limited elongation properties of steel.
- 0.5mm thick, sold by the coil.
- Spot welded to held prevent unravelling.

SKU	Width mm	Length m	Breaking Strain	Weight kg
RIB13	13mm	320m	560kg	16.5kg
RIB16	16mm	332m	720kg	21kg
RIB19	19mm	316m	850kg	25kg



Steel Strapping Kits

- All items required to manually strap using steel strapping.
- Choice of 13, 16 or 19mm steel strapping.

Contains

- Mobile dispenser
- Tensioner & Sealer
- 1 Coil of strapping 13,16 or 19mm
- 2000 Snap on Seals



RIB19KIT

Stainless Steel Strapping

- Best choice of strapping for prolonged outside uses.
- Used in marine and medical environments. Most commonly seen on roadside signs.

SKU	Width mm	Thickness	Length
SSB12	12mm	.726mm	30m
SSB19	19mm	.726mm	30m



Stainless Steel Buckles

- Knockdown buckles for use with stainless steel strapping only.
- Requires SBT tensioner.

SKU	Width mm	Seals / Box	Weight
SBK12	12mm	100	0.8kg
SBK19	19mm	100	1.3kg



Stainless Steel Tensioner

- Suitable for use with 12-19mm stainless steel strapping.



SBT



Cardboard Warehouse Storage Bins

- **Lightweight** - Move, rearrange and modify your pick locations as required.
- **Reduce Errors** - Small compartments for each item. Shelf edges can display barcodes or labels.
- **Save Space** - Change layout easily when demand requires.
- **Modify** - Add an extra shelf to each compartment.
- **Easy Assembly** - No tools required, cardboard shelves slot together.

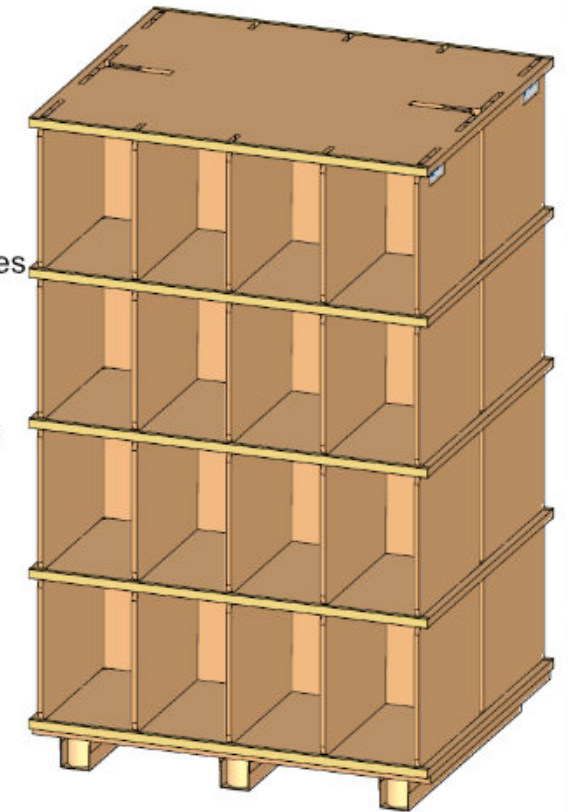

Cardboard Shelving

Designed and manufactured in the UK, the pick location shelving is made from cardboard honeycomb material.

The unique material offers considerable strength, a 32 compartment unit can hold up to 500kg.

Easily move and rearrange with forklifts and pallet trucks.



XL Cardboard Pick Bins

- **Large Compartments** - Store bigger items in the XL Bin Box
- **Strong** - Each pick bin can hold 25kg.
- **Flexible** - Two bins per layer, with the ability to pick from both sides if required.

Visit Our Show Room To View The Picking Shelves For Yourself.

We Also Sell Warehouse Supplies



Ladders



Warehouse Protection



Office Furniture



Storage and Lockers



Workbenches and Packing Stations



Warehouse Waste Management



Sack, Dollies and Pallet Trucks



Shelving

Enquire Today
01283 551050
Sales@PHFlexible.com

Paper Bags

Block Bottom Paper Bags

- 100% paper bag, easily recyclable.
- All sizes are internal.

SKU	Size mm	Pack Qty	Colour
3LB	150 x 215 x 300mm	250	Kraft
5LB	150 x 215 x 350mm	250	Kraft
7LB	175 x 288 x 350mm	250	Kraft
10LB	200 x 315 x 375mm	250	Kraft
14LB	200 x 315 x 475mm	125	Kraft
21LB	250 x 388 x 413mm	125	Kraft
28LB	250 x 388 x 550mm	125	Kraft
05KG	76 x 133 x 229mm	1000	White
1KG	108 x 168 x 215mm	1000	White
15KG	114 x 191 x 311mm	500	White



Take Away Paper Bags

- 100% paper bag, easily recyclable.
- All sizes are internal.

SKU	Size mm	Pack Qty	Paper / Handle	Thickness
7108B	175 x 260 x 225mm	250	Brown / Tape	70gsm
7108W	175 x 260 x 225mm	250	White / Tape	70gsm
81310B	215 x 325 x 250mm	250	Brown / Tape	70gsm
81310W	215 x 325 x 250mm	250	White / Tape	70gsm
101512B	250 x 380 x 300mm	250	Brown / Tape	80gsm
101512W	250 x 380 x 300mm	250	White / Tape	80gsm
1217BTW	305 x 430 x 405mm	150	Brown / Tape	80gsm
1217WTW	305 x 430 x 405mm	150	White / Tape	80gsm



Kraft Paper Bags

- 100% paper bag, easily recyclable.
- All sizes are internal.
- 37 GSM

SKU	Size mm	Paper / Handle	Pack Qty
77K	175 x 175mm	Strung	1000
88K	215 x 215mm	Strung	1000
1010K	250 x 250mm	Strung	1000
1212K	315 x 300mm	Strung	500
1314K	325 x 350mm	Strung	500
1418K	350 x 450mm	Strung	500
1921K	475 x 525mm	Strung	500



Polythene Bags With PWN

- Printed suffocation notice and air holes.
- All sizes are internal.

SKU	Size mm	Thickness	Pack Qty
1012PWN	250 x 300mm	100g / 25mu	1000
1215PWN	300 x 375mm	100g / 25mu	1000
1218PWN	300 x 450mm	100g / 25mu	1000
1520PWN	375 x 500mm	100g / 25mu	1000
1824PWN	450 x 600mm	100g / 25mu	500



Greeting Card Bags

- Resealable adhesive strip.
- 25 Micron.
- 100% Polypropylene.
- All sizes are internal.

SKU	Size mm	Pack Qty
57CBR	128 x 178 +32mm	1000
68CBR	165 x 222 x +32mm	1000
811CBR7LB	207 x 283 + 32mm	1000



Punch Handle Carrier Bags

- 50 Micron.
- Available in a range of colours.

SKU	Size mm	Pack Qty	Colour
PHC812	200 x 300mm	500	White, Black, Burgundy, Dark Blue, Gold, Harrods Green, Ivory, Silver, Yellow.



Varigauge Polythene Bags

- Thicker material by the handle provides stronger support for carrying the contents.
- 30% Recycled content.

SKU	Size mm	Micron	Pack Qty	Colour
1014CL	250 x 350 + 100mm	40/80	500	Clear
VCB10	250 x 400 + 100mm	45/90	500	White, Black, Dark Blue, Light Blue, Gold, Harrods Green, Burgundy, Silver.
VCB15	375 x 450 + 75mm	45/90	500	Black, Dark Blue, Clear, Gold, Harrods Green, Ivory, Pink, Red, Burgundy, Silver, White.
VCB22	550 x 450 + 75mm	45/90	500	Black, Dark Blue, Clear, Harrods Green, Silver, White.
VCB28	700 x 575 + 100mm	45/90	250	White, Harrods Green.



Glue Guns

- Industrial glue guns designed for constant use in a busy working environment.
- Choice of 12mm or 18mm version.



GX300

- Industrial 12mm glue gun, producing 24 grams of glue per minute.
- Suitable for use with all our 12mm glue types.
- Additional nozzles available.

Specification	
Glue Output	24g/min
Operating Temp	120-230
Glue Diameter	12mm
Compatible With	FSS12, HSS12, LTS12, MPS12
Weight	2.25kg



GX600

- Heavy duty glue gun designed for constant use.
- High glue output with an integral stand for quick usage.

Specification	
Glue Output	42g/min
Operating Temp	140-230
Glue Diameter	18mm
Compatible With	FSS12, HSS12, MPS12
Weight	2.5kg

Glue Sticks

Spec	FFS	MPS	LTS	HSS
	Fast Set glue, perfect for use with cardboard in busy packing environments	Multipurpose hotmelt glue, performs well on a range of substrates.	Low Melt sticks are suitable for use with heat sensitive items. Use at a lower glue temp.	High Strength adhesive provides a strong adhesion to items which might otherwise be difficult to adhere.
Set Time	5-10 Seconds	20-30 Seconds	15-20 Seconds	20-30 Seconds
Plastic		●		●
Wood				●
Textile		●	●	●
Polystyrene		●	●	
Cardboard	●		●	
Metal				●
Ceramic				●
12mm Code	FFS12	MPS12	LTS12	HSS12
18mm Code	FFS18	MPS18		HSS18



Staplers

Staplers

- Quickly secure a cardboard box or materials together with our range of staplers. Suitable staples are shown in the green boxes.

Carton Stapler



32-15S
32-18S

MAN27

- Manual carton stapler for closing the top of a filled box.

Pneumatic Carton Stapler



32-15S
32-18S

AIR27

- Air powered for ease of use. Use to secure top of filled cardboard boxes.

Pneumatic Anvil Stapler



SP50-10B-K

- Compresses material for strong closure.
- Used on cardboard boxes and container inserts.
- Use with **SB10302012**, **SB10302038** or **SB10302058** staples.

Anvil Stapler



73-8S
73-10S
73-12S

R31

- Heavy duty plier stapler.
- Powerful stapler which can easily staple through cardboard.

Hammer Tacker



S140-6
S140-8
S140-10

R11

- Hammer Stapler.
- Secure product to items in a hammer motion. Ideal when you can not fit a stapler around an item.

High Impact Hand Tacker



S13-4
S23-10

R23

- High impact hand tacker.
- Secure upholstery products or displays to a wall.

Hand Tacker



S140-6
S140-8
S140-10
S140-12
S140-14

R34

- Hand tacker stapler.
- Used to secure items to wood.

Manual Treadle Stapler



32-15S
32-18S

TRED27

- Used to secure the base of cartons.
- Hands free sealing, allowing you to align perfectly.
- Manual foot operated.

Pneumatic Treadle Stapler



32-15S
32-18S

TRED27AIR

- Used to secure the base of cartons.
- Hands free sealing, allowing you to align perfectly.
- Reduce operator fatigue with pneumatic powered treadle stapler.

Make It Bespoke

- Having packaging which is designed for you can bring a range of benefits.
- Efficiency** - Increase packing speeds by utilising self seal strips or crash lock bases.
- Savings** - Have packaging which uses the right amount of material.
- Transport** - Do not ship unnecessary void fill.
- Branding** - Printed packaging can increase brand awareness.

MAKE IT BESPOKE

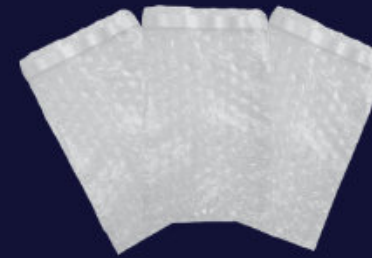

Bubble Bags

Manufactured in house to your requirements. Available in standard, double laminate, flush top, anti-static or as tubing.



Foam Bags

Converted into your bespoke size with a low MOQ. Sheets also available.



Cardboard Boxes

Bespoke boxes manufactured to your requirements. Available in various styles and thickness.



Bespoke Labels

Multitude of uses, increase branding, stock taking, barcoding or presentation with our labels, designed to your requirements.

- Plain or printed
- Low MOQ.



Printed Tape

Cost effective method of adding branding to packaging.

- MOQ of only 72 rolls.



Polythene Bags

Bespoke sized bags mean you do not pay for the material you are not going to use.

- Choice of thickness
- MOQ 250kg



Die Cut Boxes

Designed for your intricate needs, providing a unique package which is made to your specification. This could include an ideal shipping box, with fitments to secure your items in place.



Printed Boxes

Increase branding and visibility on your packaging by printing your logo. Options for all quantities, stamped, digital, litho or flexo printing available.



E-commerce Packaging

Streamline your packing process by increasing packing speeds, complying with shipping requirements and offering a customer unboxing experience with bespoke packaging.